

10 - Biological specimen preparation

BEEM® capsules

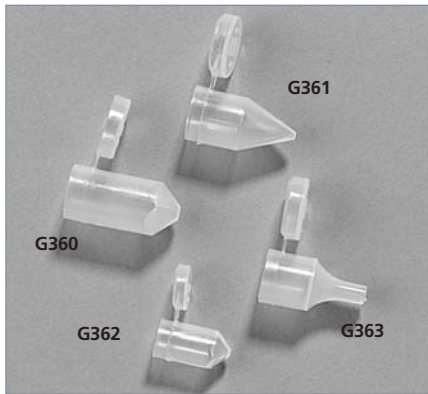

These are pre-shaped polyethylene moulds with hinged lids. Resin blocks are produced which require virtually no trimming prior to sectioning. A range of shapes is available.

BEEM 00 pyramidal

Pyramid shaped capsules with 1 mm square tips.

G360-1 BEEM capsules, 00 pyramidal. Pack of 100

G360-2 BEEM capsules, 00 pyramidal. Pack of 1000

BEEM 00 conical

Conical tip capsules suitable for particles centrifuged into a pellet and for very small pieces of tissue.

G361-1 BEEM capsules, 00 conical. Pack of 100

G361-2 BEEM capsules, 00 conical. Pack of 1000

BEEM 00 hemi-hyperbola

Capsules useful for embedding very small or elongated pieces of tissue.

G363-1 BEEM capsules, 00 hemi-hyperbola. Pack of 100

G363-2 BEEM capsules, 00 hemi-hyperbola. Pack of 1000

BEEM 3 capsules

Capsules similar in shape to BEEM size 00, but corresponding to size 3 gelatin capsules.

G362-1 BEEM capsules, size 3. Pack of 100

G362-2 BEEM capsules, size 3. Pack of 1000

BEEM capsule holder 00



This numbered rack for 22 BEEM 00 capsules holds them upright for filling and curing. A vacuum relief hole in the bottom of each depression permits light transmission for examination of the blocks. This holder is also suitable for gelatin capsules.

G364 BEEM capsule holder, size 00

BEEM capsule holder 3

Rack designed to hold the smaller size 3 BEEM capsules. It will also accommodate small gelatin capsules.

G365 BEEM capsule holder, size 3

BEEM UV transparent capsule holder

This polypropylene rack is suitable for holding 22 size 00 capsules during UV polymerisation.

G3525 UV BEEM capsule holder, size 00



BEEM capsule press

Hand operated press for safely releasing blocks from BEEM capsules, without damaging the blocks.

G368 BEEM capsule press

G368A Adaptor for size 3 capsules



BEEM flat embedding mould

This transparent polyethylene re-usable mould with 12 numbered cavities provides smooth, flat, polished blocks. The transparent nature of the mould facilitates specimen orientation when transmitted light is used. Particularly useful for embedding media such as JB-4® and methacrylates, which do not polymerise well in conventional moulds. May also be used with LR White™ provided it is covered.

Supplied in a plastic box with hinged lid.

G3654 BEEM flat embedding mould

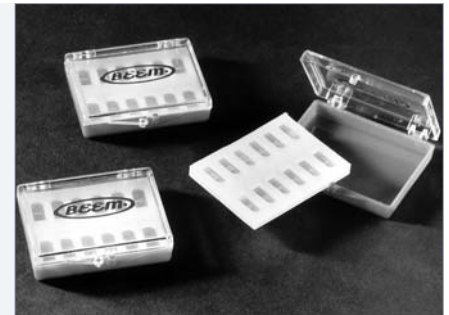

BEEM block holder module

A small box holding 10 blocks of size 00 in numbered compartments. Clear plastic, snap fit cover.

G366 BEEM block holder module



BEEM Dial-a-Grid and block holder module

This box holds 24 grids in numbered diamond-shaped compartments. The design exposes one grid at a time. It also holds two BEEM size 00 resin blocks.

G3694 BEEM Dial-a-Grid and block holder module

Embedding capsules (flat ended)



Flat ended capsules, 8 mm in diameter, available in polyethylene for embedding at temperatures up to 75 °C, or polypropylene for embedding at temperatures up to 100 °C.

G3744 Embedding capsules, flat, polyethylene. Pack of 500

G3759 Embedding capsules, flat, polypropylene. Pack of 500

Gelatin capsules

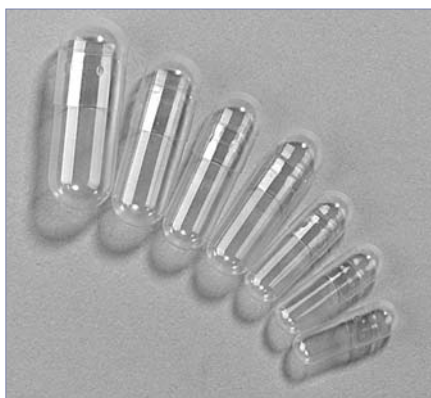

Pure gelatin capsules, providing a convenient and economical means of producing resin blocks for sectioning. They are easy to remove from the resin block prior to sectioning.

Capsule size	Volume (ml) SG = 1	Diameter (mm)
000	1.37	9.5
00	0.95	8.5
0	0.68	7.0
1	0.50	6.5
2	0.37	6.0
3	0.30	5.5
4	0.21	5.0

G29209 Gelatin capsules 000. Pack of 100

G29219 Gelatin capsules 000. Pack of 1000

G29208 Gelatin capsules 00. Pack of 100

G29218 Gelatin capsules 00. Pack of 1000

G29200 Gelatin capsules 0. Pack of 100

G29210 Gelatin capsules 0. Pack of 1000

G29201 Gelatin capsules 1. Pack of 100

G29211 Gelatin capsules 1. Pack of 1000

G29202 Gelatin capsules 2. Pack of 100

G29212 Gelatin capsules 2. Pack of 1000

G29203 Gelatin capsules 3. Pack of 100

G29213 Gelatin capsules 3. Pack of 1000

G29204 Gelatin capsules 4. Pack of 100

G29214 Gelatin capsules 4. Pack of 1000

All quantities are approximate. Other sizes are available on request.

Snap-Fit® gelatin capsules

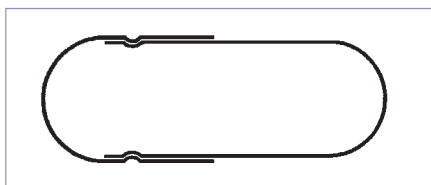

Snap-Fit gelatin capsules, useful for embedding specimens and storage of small items.

Available in two sizes: Size 00 (8.5 mm dia, 0.95 ml capacity)

 Size 1 (6.5 mm dia, 0.50 ml capacity)

G3740 Snap-Fit gelatin capsules, size 00. Pack of 1000

G3741 Snap-Fit gelatin capsules, size 1. Pack of 1000

Gelatin capsule holder

Holder for 15 size 00 gelatin capsules, for easy embedding.

G3567 Gelatin capsule holder, size 00

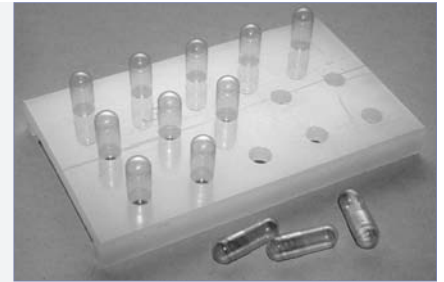

Polypropylene capsule chambers

This polypropylene, transparent capsule chamber with hinged, snap cap closure is useful for flat embedding.

Dimensions: 26 mm internal diameter, 10 mm high.

G3679 Polypropylene capsule chambers. Pack of 100



Micromoulds

Self-supporting strips of 10 size 00 (8 mm dia) numbered embedding moulds. Moulds are polythene, and produce pyramidal tips with a 1 mm square top.

G3505 Micromoulds. Pack of 10 strips

G3515 Micromoulds. Pack of 100 strips



Easy-moulds

These polyethylene moulds have transparent tips, which facilitate rapid specimen orientation. Polymerised blocks can be removed by thumb pressure. The moulds come as a free standing stack of 20 embedding compartments, allowing circulation of air for even polymerisation. For anaerobic resins the moulds are self-stacking. Used moulds are convenient for storage of blocks after sectioning.

G3742 Easy-moulds, 5.6 mm dia. Pack of 5

G3743 Easy-moulds, 8.0 mm dia. Pack of 5

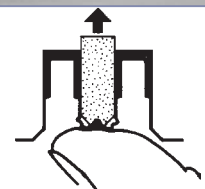
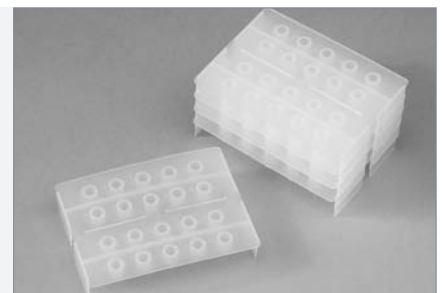

Aluminium dishes

Flat aluminium dishes, useful as embedding moulds. The fluted sides expand to release the polymerised resin block. Available in two sizes: 53 (d) x 17 (h) mm and 43 (d) x 12.5 (h) mm.

G3651 Aluminium dishes, 53 mm dia. Pack of 144

G3912 Aluminium dishes, 43 mm dia. Pack of 100

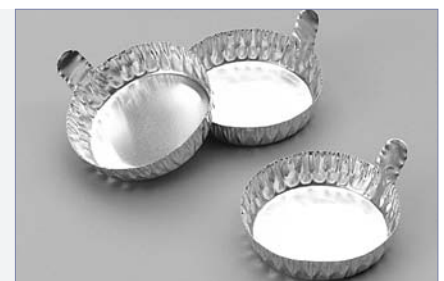

Plastic embedding stubs

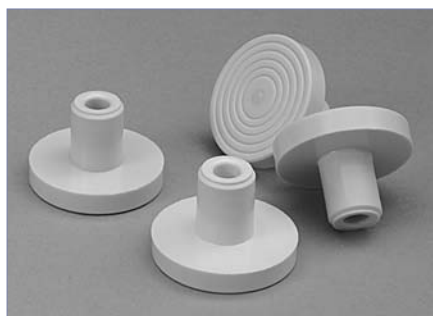

Manufactured from rigid plastic which bonds to all resins. May be used with disposable moulds (**G3553/G3554/G3555**).

G3552 Embedding stubs. Pack of 100

Disposable plastic moulds



These are disposable, transparent plastic moulds. Each mould has five impressions. Suitable for use with plastic embedding stubs (**G3552**), to produce ready mounted blocks for direct attachment to a microtome.

G3553 Embedding moulds, 13 x 5 x 5 mm. Pack of 50

G3554 Embedding moulds, 13 x 8 x 5 mm. Pack of 50

G3555 Embedding moulds, 12 x 15 x 5 mm. Pack of 50

Moulding trays



Lightweight, durable polyethylene trays, ideal for embedding specimen blocks of JB-4® and other resins. The matt surface is easily marked for identification purposes. Can be used with plastic block holders.

G3750 Moulding tray, 6 x 12 x 5 mm, 20 cavities

G3751 Moulding tray, 12 x 16 x 5 mm, 20 cavities

G3752 Moulding trays, 6 x 8 x 5 mm, 9 cavities. Pack of 3

G3753 Moulding trays, 2 x 15 x 5 mm, 9 cavities. Pack of 3

G3754 Moulding trays, 13 x 19 x 5 mm, 9 cavities. Pack of 3

G3755 Plastic block holders. Pack of 50

Peel-A-Way® disposable embedding moulds

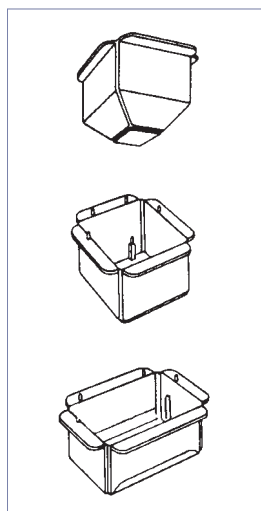

These Peel-A-Way moulds are suitable for most plastic embedding media, particularly paraffin waxes and for cryo applications. They may be used under anaerobic conditions. The moulds are available in three shapes: square, rectangular and pyramid. Tabs are available to use as identification with the embedding moulds.

G3760 Peel-A-Way moulds, square, 22 x 22 x 20 mm. Pack of 288

G3761 Peel-A-Way moulds, rectangular, 22 x 30 x 20 mm. Pack of 288

G3762 Peel-A-Way moulds, rectangular, 22 x 40 x 20 mm. Pack of 264

G3763 Peel-A-Way moulds, pyramid, 22 mm square top tapering to 8 mm base. Pack of 288

G3764 Peel-A-Way moulds, pyramid, 22 mm square top tapering to 12 mm base. Pack of 288

G3929 Peel-A-Way ID tabs. Book of 8000

Polythene cups

A range of polythene cups, originally intended as stoppers, suitable for use as disposable flat embedding moulds.

- G3140-1** Polythene cups, 35 (dia) x 22 mm. Pack of 50
- G3140-2** Polythene cups, 28 (dia) x 18 mm. Pack of 50
- G3140-3** Polythene cups, 22 (dia) x 16 mm. Pack of 50
- G3140-4** Polythene cups, 18 (dia) x 14 mm. Pack of 50



Large histological moulds

Convenient silicone rubber moulds for four embedding blocks, suitable for large section light microscopy applications. Available in four mould sizes, on 25 x 25 mm bases. Also available in a more resistant rubber.

Normal rubber:

- G3500** Histological mould size A, 10 x 10 mm
- G3501** Histological mould size B, 10 x 15 mm
- G3502** Histological mould size C, 10 x 20 mm
- G3503** Histological mould size D, 10 x 25 mm

Resistant rubber:

- G3510** Histological mould size AR, 10 x 10 mm
- G3511** Histological mould size BR, 10 x 15 mm
- G3512** Histological mould size CR, 10 x 20 mm
- G3513** Histological mould size DR, 10 x 25 mm



Giammara-Hanker Cast-A-Slide translucent mould

This silicone rubber mould produces two slides. Fixed Vibratome® sections or cytochemically stained cells post fixed with osmium tetroxide are dehydrated and infiltrated with resin by routine embedding methods. The specimen is placed in the mould recess and resin gently poured on top. Selected specimens can be cut out and glued onto blank blocks for ultramicrotomy.

- G3524** Giammara-Hanker Cast-A-Slide translucent mould



Resins

For full range of fixatives, buffers and resins etc., please refer to section 13.

Teflon® moulds for flat embedding



These moulds are particularly suited for use with acrylic resins eg. LR White™, LR Gold™ and Lowicryls®. They can be used for low temperature, UV and thermal polymerisation.

They can also be used with Thermanox™ coverslips, ACLAR® or Melinex® film to ensure anaerobic polymerisation.



After curing, each of the specimen blocks can be removed by flexing the Teflon mould. The flatness of the mould can be restored by sliding it back into the metal clamping frame.



Teflon is non-reactive, durable, flexible and allows easy release of resins.

Three types of mould are available: one with 16 cavities (14 x 4.8 x 3 mm), one with 11 size 00 cavities, and one with three cavities (36.6 x 13.8 x 3 mm).

G3747 Teflon mould, 16 cavities

G3795 Teflon mould, 11 cavities

G3748 Teflon mould, 3 cavities

Pyramid tip mould

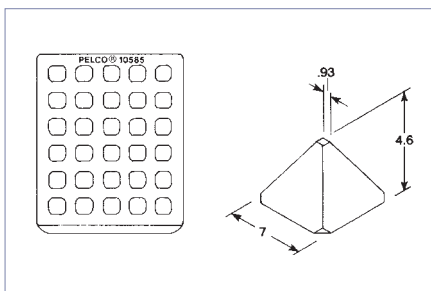

A blue silicone rubber mould with 30 numbered cavities, particularly useful for difficult to orientate specimens. The tips can be glued easily to plastic mounting cylinders, producing tips with identical dimensions to BEEM® size 00 capsules.

G3745 Pyramid tip mould

G3746 Mounting cylinders. Pack of 100

Flat embedding moulds

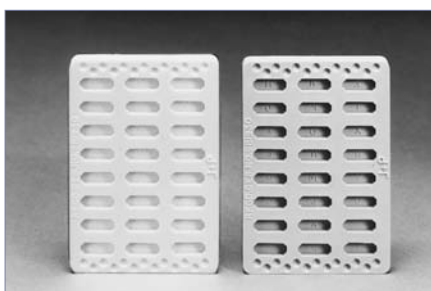

Flat silicone rubber embedding mould with 24 numbered 12.5 x 4.5 x 3 mm cavities. Each cavity is double ended with differing cross-sections at each end. There is also a group of hemispherical depressions, approximately 3 mm in diameter, for embedding droplets. The moulds are very flexible, aiding release of polymerised blocks.

G369 Flat embedding mould, white

A special blue rubber mould with the same design, but more resistant to resins, is also available.

G3690 Flat embedding mould, blue resistant rubber



Blue silicone rubber mould with 21 numbered cavities with double pre-trimmed ends. Dimensions: 72 x 62 x 6 mm.

G3549 PELCO® double end mould, 21 cavities

Flat embedding moulds

Other shapes and sizes are available in green silicone rubber.

Mould with 15 unmarked 11 x 6 x 5 mm cavities. One end will produce trapezoidal-shaped tips for easy trimming.

G3530 Flat embedding mould, 15 cavities

Mould with 20 numbered 14 x 6 x 4 mm cavities with trapezoidal-shaped tips at both ends.

G3531 Flat embedding mould, 20 numbered cavities

Mould with 24 numbered cavities of the same block size as **G3531**. Also contains three special cavities for multiple specimen embedding.

G3532 Flat embedding mould, 24 numbered cavities and 3 multi-specimen cavities

Mould with 20 unmarked rectangular 12 x 6 x 4 mm cavities, with trapezoidal-shaped tip at one end. Eight rectangular compartments are also included.

G3533 Flat embedding mould, 20 cavities plus 8 rectangular cavities

Round mould with 10 compartments. Diameter of mould is 92 mm. Useful for large or multiple specimen embedding in a single segment.

G3534 Flat, round embedding mould, 10 cavities

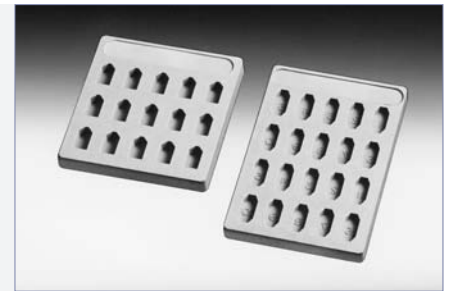

FIB SEM mould for biological specimens

This silicone rubber mould has been developed in collaboration with Cancer Research UK's London laboratories. The mould is designed to aid orientation and trimming of the sample. It produces a block which is easy to mount in the SEM for correct orientation of the block face with respect to the ion and electron beams. During FIB milling, re-deposition of sputtered material back onto the block face is minimised by positioning the sample in an overhang of resin. This four-cavity mould can be reused many times if handled with care.

G3504 FIB SEM mould

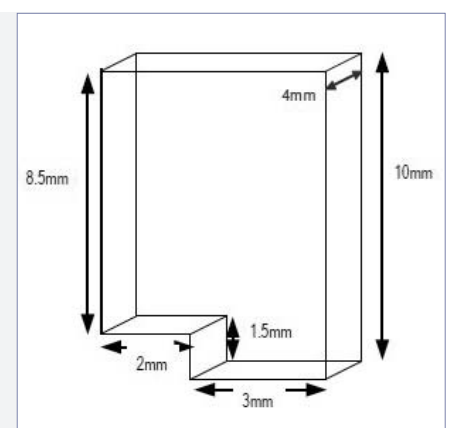

Melinex® film

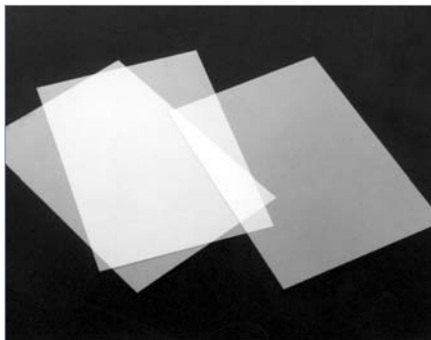

Melinex film is a convenient substrate for growing cell cultures for later incorporation into blocks. Sheet dimensions: 210 x 297 mm, 175 µm thick.

L4103 Melinex film. Pack of 5 sheets

ACLAR® film

ACLAR is a transparent thermoplastic film which cells readily adhere to for fixation, dehydrating and embedding. It is chemically inert, can be sterilised and separates easily from epoxy resins. It can be cut with razor blades or scissors, and does not damage microtome knives. It can also be used as an oxygen barrier when flat embedding acrylic resins.

L4457 ACLAR 33C embedding film, 203 x 254 mm sheets, 0.05 mm thick. Pack of 10

L4457-25 ACLAR 33C embedding film, 203 x 254 mm sheets, 0.05 mm thick. Pack of 25

L4458 ACLAR embedding film, 200 x 315 mm, 0.2 mm thick. Pack of 10

L4459 ACLAR embedding film, 200 x 315 mm, 0.2 mm thick. Pack of 25

For details of a range of Thermanox™ coverslips, please refer to page 150.

Tri-Pour® beakers



Polypropylene beakers, graduated in 10 ml increments. They are leak proof and unbreakable which makes them suitable for deep freeze storage. The sloping sides allow easy stacking. They are autoclavable and stain free. Tight fitting caps are also available.

G3350 Tri-Pour graduated beakers, 50 ml. Pack of 25

G3351 Tri-Pour graduated beakers, 100 ml. Pack of 25

G3352 Tri-Pour graduated beakers, 250 ml. Pack of 25

G3353 Tri-Pour graduated beakers, 400 ml. Pack of 25

G3355 Tri-Pour graduated beakers, 800 ml. Pack of 25

G3354 Tri-Pour graduated beakers, 1000 ml. Pack of 25

Tight fitting caps for Tri-Pour beakers



G3360 Caps for 50 ml beakers. Pack of 25

G3361 Caps for 100 ml beakers. Pack of 25

G3362 Caps for 250 ml beakers. Pack of 25

G3363 Caps for 400 ml beakers. Pack of 25

G3365 Caps for 800 ml beakers. Pack of 25

G3364 Caps for 1000 ml beakers. Pack of 25

Polyethylene graduated containers

These small polyethylene cups with approximate volume graduations are ideal for mixing embedding materials. Clip-on caps are available.

G332 Graduated containers, 100 ml. Pack of 100

G333 Caps for 100 ml containers. Pack of 100



Disposable stirrers

Flat wooden sticks, suitable for stirring resins, etc.

G3322 Disposable stirrers. Pack of 100



Disposable polyethylene storage syringes

Ungraduated, polyethylene syringes suitable for frozen storage of embedding media, ready for convenient dispensing into capsules. Available in three sizes and supplied with tip caps.

Tip dimensions: 1.6 mm inside diameter at opening, 28.6 mm length.

G3394-15 Disposable plastic syringe, 15 ml. Pack of 20

G3394-30 Disposable plastic syringe, 30 ml. Pack of 20

G3394-60 Disposable plastic syringe, 60 ml. Pack of 20



Microcentrifuge tubes

Transparent polypropylene, 1.5 ml microcentrifuge tubes with 0.5 ml graduations.

G3711 Microcentrifuge tubes, clear. Pack of 100



Manufactured from high quality coloured polypropylene that withstands forces up to x30,000G. Graduated 0.1 and 0.25 ml. Available in red, yellow, blue, green and orange. 100 of each make a pack of 500.

G3711C Microcentrifuge tubes, assorted colours. Pack of 500



Variable speed specimen rotator



This fixed tilt rotator holds up to 12 glass vials. It is designed to improve penetration of fixatives and resins into biological tissues prior to polymerisation. It has continuously variable speed in the range of 2 to 26 rpm. The compact size allows the rotator to be used in a refrigerator or incubator, as well as on the bench. Additional discs are also available.

Dimensions: 153 x 150 x 175 mm.

- B7925** Specimen rotator, 220/240 V, 50/60 Hz
- B7925A** Disc with 18 mm holes
- B7925B** Disc with 11 clips, 20 - 26 mm
- B7925C** Disc with 16 clips, 10 - 14 mm

Embedding oven



Compact embedding oven with high thermal capacity, giving excellent thermal stability. It has self-stacking carrier trays, on which BEEM® capsule holders can be placed (holder **G364** for size 00, and holder **G365** for size 3). The operating temperature is selected by the control dial.

- Temperature range: 40 - 100 °C
- Temperature accuracy/
differential throughout oven: 0.5 °C
- Power consumption: 100 VA
- Internal dimensions: 225 x 145 x 140 mm
- External dimensions: 335 x 305 x 230 mm

- B702** Embedding oven, 230 V, 50/60 Hz
- B703** Embedding oven, 110 V, 60 Hz

Vacuum oven lid

Lid to convert the embedding oven (**B702/B703**) into a vacuum oven, ideal for the polymerisation of resins in a vacuum or inert atmosphere, and for wax impregnation of specimens. Lid incorporates vacuum gauge, valves and viewing window.

- B705** Oven vacuum lid

Compact embedding oven



A compact embedding oven ideally suited to polymerisation of resins in a fume cupboard. The temperature is controlled by a thermostat fitted to a calibrated scale with a locking device. There is a hole in the top of the oven for a thermometer. The oven contains two removable shelves.

- Temperature range: 40 - 250 °C
- Temperature accuracy: 0.75 °C
- External dimensions: 400 x 330 x 300 mm
- Internal dimensions: 150 x 230 x 190 mm

- B7606** Compact embedding oven, 220/240 V, 50 Hz

General purpose oven

Highly efficient and reliable oven for cost effective drying, warming and general laboratory applications. The temperature is controlled by a thermostat fitted to a calibrated scale with a locking device. There is a hole in the top of the oven for a thermometer, and it contains two removable shelves.

Temperature range:	40 - 250 °C
Temperature accuracy:	0.75 °C
External dimensions:	520 x 380 x 410 mm
Internal dimensions:	260 x 260 x 270 mm

B7608 General purpose oven, 220/240 V, 50 Hz



UV polymerisation unit

UV irradiation unit for uniform polymerisation of acrylic resins. Contains two 6 watt tubes with a maximum emission at ~360 nm. Can be operated manually, or using the timer provided, with a safety light to indicate when the unit is switched on. A stainless steel tray in the base offers easy cleaning.

External dimensions: 310 x 408 x 280 mm.

B7607 UV polymerisation unit, 220/240 V, 50 Hz



UV lamp

Embedding media can be cured or polymerised by UV irradiation instead of heat. Some acrylic resins need to be polymerised at low temperature by UV irradiation. This lamp provides the necessary source. The wavelength is 360 nm and a filter prevents harmful wavelengths from being observed. Supplied in a carrying case. Unit contains 2 x 6 watt tubes.

B7960 UV lamp, 240 V

B7920A Replacement UV tube, 6 W



Diamond knives

Diamond knives are available for ultrastructural, histological and cryo sectioning of biological materials.

For details of diamond knives, please refer to section 14.



Cleaning sticks



Special high density polystyrene foam sticks offer excellent cleaning of diamond knives, while minimising the risk of damage. Ordinary polystyrene foam is not suitable for this application.

C899 Polystyrene cleaning strips. Pack of 6

Pith

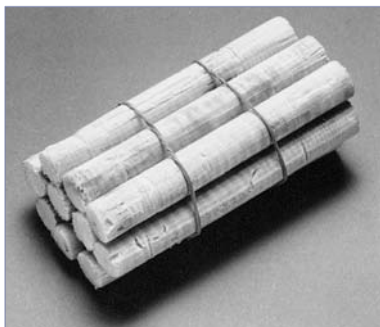

Pith for cleaning diamond knives.

C803 Pith. Bundle of 10

GKM glass knifemaker

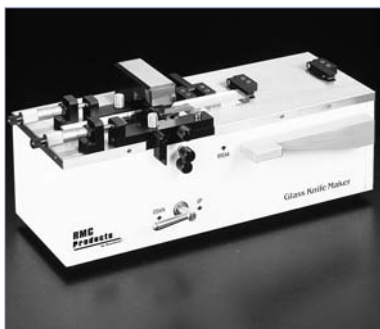

A compact and portable glass knifemaker for producing knives up to 12 mm wide. It is machined from a solid block of metal for long term stability and precision, and has been engineered with mechanical stops for producing precise 25 mm glass squares. Sophisticated load sensors and micrometer positioners offer controlled, consistent breaks for optimum knife edges. Uses ultramicrotome glass ranging from 6 to 12 mm. It is supplied complete with protective goggles, brush, replacement scoring wheel and axle, and a box of 6 mm thick glass strips.

Dimensions: 160 x 360 x 170 mm. Weight: 13.6 kg

B7072 GKM glass knifemaker

GKM-2 glass knifemaker



Alternative model in the GKM glass knifemaker series. For producing glass knives up to 12 mm wide. It is specifically designed to incorporate the 'balanced break' method for consistent, straight breaks to produce optimum knife edges. The position of the glass is precisely controlled by two micrometers, to ensure equal lengths of glass on either side of the score. The load applied to the glass is controlled through the constant feedback displayed on the digital readout. The clamping handle and breaking arm can be adjusted so that equal load is applied to either side of the break. The precision mechanism also supports the 'slow break' technique. Uses ultramicrotome glass ranging from 6 to 12 mm. It is supplied complete with protective goggles, brush, replacement scoring wheel and axle, and a box of 6 mm thick glass strips.

Dimensions: 160 x 360 x 170 mm. Weight: 13.6 kg

B7073 GKM-2 glass knifemaker

LKB knifemaker kit

A kit of replacement parts for LKB knifemakers, including cutting wheel, axle, damping pad and two knife guiding rings.

L4517 LKB knifemaker parts kit

Glass for glass knives

High quality glass for the production of consistent glass knives for specimen trimming, thick, semi-thin and ultrathin sectioning and cryo ultramicrotomy. This glass is produced to very close mechanical tolerances and is suitable for use with Leica/LKB and other knifemakers. Each strip is prewashed and individually wrapped to ensure it remains clean until ready for use.

Ultramicrotome glass for Leica/LKB knifemakers

G329 Glass strips, 406 x 25 x 6 mm. 30 pieces

G3516 Glass strips, 406 x 25 x 8 mm. 24 pieces

G330 Glass strips, 406 x 25 x 10 mm. 15 pieces

G336 Glass strips, 203 x 51 x 6 mm. 50 pieces

Histology glass for Ralph knifemakers

G335 Glass strips, 406 x 25 x 6 mm. 30 pieces

G3647 Glass strips, 406 x 38 x 6 mm. 20 pieces



Glass strips are also available for RMC and Bio-Rad knifemakers. Please ask for details.

Glass cutting wheel

A high quality tungsten wheel cutter.

T574 Glass cutting wheel



Diamond glass cutter

A polished diamond cutter with a rosewood handle. Capable of achieving a very clean, deep split in glass.

T564 Diamond glass cutter



Glass breaking pliers



Substantial pliers designed to give a good break. They have an end mark on the jaws to locate the break line.

T573 Glass breaking pliers

Glass knife storage box

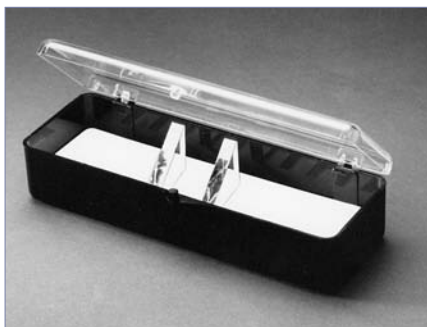

A polystyrene box with a silicone rubber insert for secure storage of ten 25 x 25 x 6 mm glass knives, protecting them from dust and damage.

G3693 Glass knife storage box

Glass knife holders



These dust free containers have silicone rubber mats with numbered recesses for 16 knives. Two sizes are available to hold 25 x 25 x 6 - 7 mm or 25 x 25 x 8 mm knives.

G3749 Glass knife holder for 6 - 7 mm thick glass knives

G3749A Glass knife holder for 8 mm thick glass knives

LKB Trufs



These are disposable, moulded plastic troughs for fitting to glass microtome knives. They provide a reproducible and clean trough which is quickly and easily attached to the glass knife with wax. The Trufs have ample capacity for large ribbons of sections.

G3327 LKB Trufs. Box of 500

G3327A LKB Trufs. Box of 100

PVC tape

Tape suitable for making boats on glass microtome knives.

G260 PVC tape for boats, 9 mm x 33 m

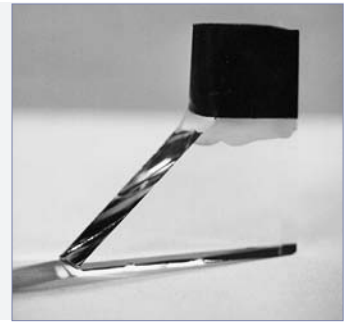

Silver tape

Silver coated polyester tape for making microtome boats.

G262 Silver tape, 9 mm x 66 m



Dental wax

This low melting point wax is used for sealing tape boats and Trufs onto glass knives.

May also be used as a base for staining grids, or for immunolabelling sections. Supplied in approximately 24 sheets (185 x 90 mm).

G381 Dental wax. 500 g



Tackiwax

Wax to keep ultramicrotome cut sections in a neat row, simply by applying a thin layer of wax to the sides of the block face at the top and bottom of the trapezoid.

G384 Tackiwax. 10 g



Storage boxes

For full range of storage boxes, please refer to section 23.

Biological specimen preparation

Polypropylene cups



Static free, graduated 30 ml polypropylene cups, ideal for preparing water for glass or diamond knife troughs. They ensure distilled water is static free, so that serial sections will not move around the trough.

G3396 Polypropylene cups, 30 ml. Pack of 100

Polyethylene mincing dishes

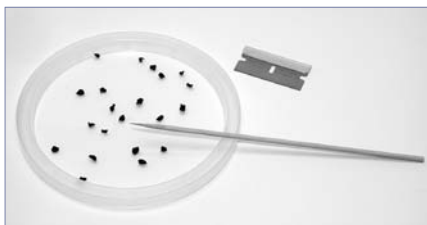

100 mm diameter dishes for trimming, cutting and specimen preparation.

G3918 Mincing dishes. Pack of 100

Bamboo splints



Bamboo splints offer a simple method for holding tissues for mincing or cutting. Pointed on one end. 150 mm long.

C839 Bamboo splints. Pack of 100

Razor blade holder



A simple device designed to safely hold unbacked single edge razor blades. Easy to reload.

T567 Razor blade holder
T568 Replacement blades, carbon steel. Dispenser of 20
T569 Replacement blades, carbon steel. Box of 250
T569A Replacement blades, stainless steel. Box of 250

Razor blades

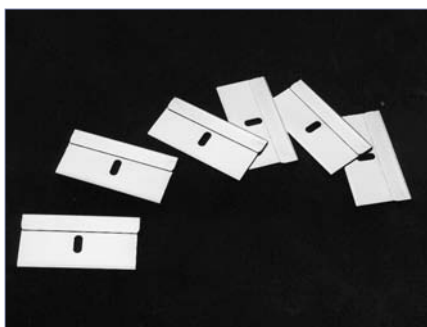

Single edge backed blades suitable for block trimming and specimen preparation.

T585 Single edge razor blades, carbon steel. Box of 100
T586 Single edge razor blades, stainless steel. Box of 100
T5016 Single edge razor blades, heavy duty carbon steel. Box of 100
T5332 Single edge razor blades, Teflon® coated stainless steel. Box of 100

Miniature saw

Miniature saw for cutting up flat embedded blocks. Dimensions: 75 x 25 mm.

- T581** Miniature saw
- T582** Spare blades. Pack of 10



Sable hair brushes

Sable hair brushes for delicate manoeuvring of specimens and grids. Also recommended for gently dusting SEM samples.

- G3440** Sable hair brush, size 3 (4.0 mm). Set of 3
- G3441** Sable hair brush, size 2 (3.0 mm). Set of 3
- G3442** Sable hair brush, size 1 (2.0 mm). Set of 3
- G3443** Sable hair brush, size 0 (1.5 mm). Set of 3
- G3444** Sable hair brush, size 00 (1.2 mm). Set of 3
- G3445** Sable hair brush, size 000 (0.8 mm). Set of 3
- G3446** Set of six brushes, one of each size



Single bristle holder

Pen type holder with parallel jaw chuck for holding a single bristle, convenient for manoeuvring sections.

- T583** Single bristle holder
- T584** Spare bristles. Pack of 10

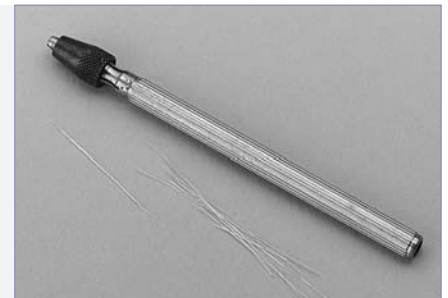

Paper points

Highly absorbent, tightly machine rolled paper points. Gripped in self-closing tweezers, they offer highly precise absorbance of wet areas or droplets on specimen block faces, without the risk of random fibres obstructing or damaging the specimen.

- T5116** Paper points. Box of 200

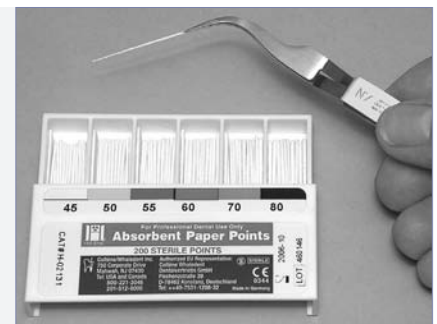

Tweezers

For full range of tweezers and small tools, please refer to section 4.

Section pick-up loop

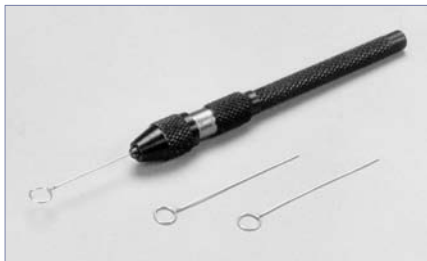

Platinum loop in a pin vice, providing a readily cleanable loop.

T5010 Specimen pick-up loop, complete

T5011 Set of 3 spare platinum loops

Nichrome loops

A range of finished Nichrome loops, with different internal diameters, for insertion into a loop handle. Nichrome wire 0.25 mm in diameter is also available from which loops can be made to the required size.

T5470 Loop handle

T5471 Nichrome loops, 1.5 mm internal diameter. Pack of 3

T5472 Nichrome loops, 3.5 mm internal diameter. Pack of 3

T5473 Nichrome loops, 5.0 mm internal diameter. Pack of 3

E444 Nichrome wire, 0.25 mm x 30m

Perfect loop

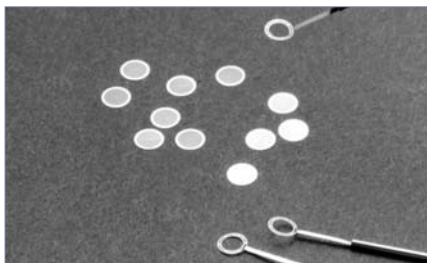

Using this loop, thin sections can be transferred easily from microtome boats to grids with a minimum of creasing or folding.

T5112 Perfect loop with handle

T5113 Replacement loop

Heat pen



This heat pen helps to reduce compression in plastic embedded sections. Suitable for replacing solvent vapour methods. Variable temperature control with coloured light bars which flash to indicate temperature and warn the operator of the hot filament. The filament and holder can be clamped onto the back of the housing when not in use.

B7962 Heat pen, 240 V

B7963 Spare filament for heat pen

Grid holders

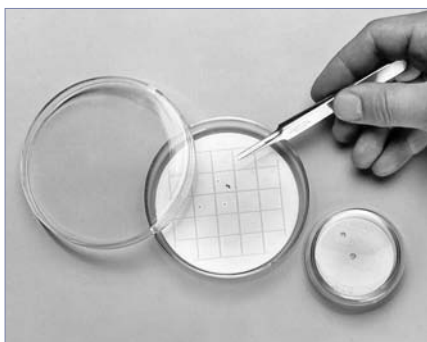

Grip-a-grid storage disc offering secure storage of grids in a Petri dish. Each disc is marked with numbered squares to allow easy identification of specimens, and prevents grids being easily knocked out of position. Grip-a-grid discs are easy to clean, and are available to fit 50 and 90 mm round and square Petri dishes.

G3306 Grip-a-grid disc, 85 mm

G3335 Grip-a-grid disc, 85 mm. Pack of 10

G3307 Grip-a-grid disc, 45 mm. Pack of 10

G3043 Grip-a-grid square, 70 x 70 mm

G3044 Grip-a-grid square, 70 x 70 mm. Pack of 10

Grid coating pen

Pen designed to apply a thin layer of adhesive to grids with minimal pressure. The adhesive will dry, ready for tissue mounting, in 1 to 2 minutes. It can also be used for pre-treating grids before working with Formvar® or other thin films.

G3538 Grid coating pen



Grid staining system

Grid staining system for 25 grids, consisting of numbered grid holder and handle, cover and staining vessels (two supplied). Plastics are not acid resistant, and staining vessels are designed for aqueous solutions. Alcohol based stains will damage the vessels.

G3756 Grid staining system

G3757 Replacement staining vessels, 1 red and 1 blue



Microwell staining mould

This blue silicone rubber mould which fits into standard Petri dishes is useful for immunocytochemistry and post staining. It has 60 wells, 4.8 mm in diameter and 1.8 mm deep, each number and letter coded for easy identification. Uses small quantities of reagents.

G3758 Microwell staining mould



Teflon® immunostaining pad

This immunostaining pad made from Teflon is resistant to most chemicals and easy to clean. It has 40 concave recesses, 4.5 mm in diameter and 1.5 mm deep, useful for small specimens or valuable chemicals. Suitable for microwave use.

Dimensions: 42 x 70 x 6.3 mm.

G3765 Immunostaining pad, Teflon



MENCO grid staining pad

PTFE staining pad, 89 mm diameter, which fits inside a large glass Petri dish. Evaporation can be reduced by covering Petri dishes with parafilm.

G3796 MENCO immunostaining pad



Chien staining pad

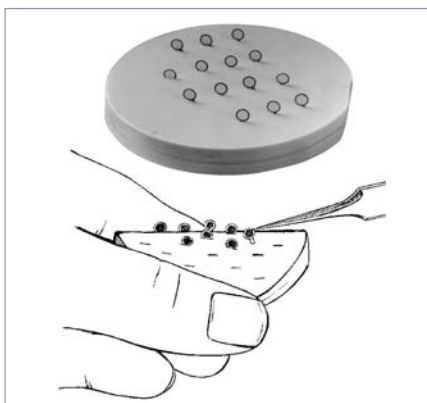

Flexible silicone pad designed for staining grids, as well as holding tabbed grids, Omniprobe grids and samples. It has 18 slots which support grids securely, even when the pad is flexed. When the pad is laid flat the grids stand vertically allowing the surface tension of the droplets of stain to cover both sides of the grid.

Suitable for microwave use.

Dimensions: 50 mm (dia), 5 mm thick.

G3766 Chien staining pad

pH meter



An easy to use, battery operated pH meter, offering bench type accuracy with automatic temperature compensation. It can be used for stirring while the readings are being taken. The electrode is replaceable. The four 1.4 V batteries give 1000 hours of use. It is supplied complete with electrode, pH 4 and pH 7 buffer solutions and a calibration adjustment screwdriver, in an ABS carrying case.

Range: pH 0.00 to 14.00

Resolution: 0.01

Accuracy: 0.01

Automatic temperature

compensation range: 0 - 70 °C

Dimensions: 172 x 29 x 15 mm

Weight: 100 g

B8105 pH meter

B8106 Spare electrode

B8107 Buffer solution pH 4. 500 ml

B8108 Buffer solution pH 7. 500 ml

B8109 Calibration screwdriver

Critical point dryers



Critical point drying is a well established method for dehydrating biological tissue prior to examination in the scanning electron microscope. A range of critical point dryers is available, with either horizontal or vertical chambers.

The basic design consists of a 75 mm horizontal pressure chamber with 32 mm internal diameter, surrounded by a water jacket. Specimens are placed in the chamber via a removable rear door. The front of the chamber is fitted with a 25 mm window, allowing the liquid level to be viewed.

Dial gauges display the pressure in the chamber and the temperature of the water circulating in the jacket. Three pressure valves permit easy connection to the liquid CO₂ cylinder, agitation of the liquid and venting of the chamber. The chamber is tested to 2500 psi (175 bar). The specimens are contained in tissue baskets with lids. The baskets are placed in a boat-shaped liquid holder. This design ensures that the specimens have no opportunity to dry out. The critical point dryer is supplied complete with specimen holder for tissues, flexible CO₂ connector and water hose.

B7010 Critical point dryer

Critical point dryers

Accessories for **B7010** Critical point dryer

- B7011** Specimen holder for grids, 3.05 mm
- B7012** Specimen holder for grids, 2.3 mm
- B7013** Specimen holder for tissue
- B7014** Tissue baskets. Set of 3
- B7031** Specimen holder for coverslips
- B7895** Porous specimen pots, 12.7 x 13 mm. Pack of 10
- B7025** Complete set of gaskets

Replacement parts also available.



Jumbo critical point dryer

A large capacity chamber is also available, for multiple samples or large samples. The chamber is 100 mm in length, with a 64 mm internal diameter, giving approximately three times the volume of the **B7010**. The transfer boat also accepts three times the number of samples, or can be modified to hold coverslips up to 25 mm in diameter. It comes with a flexible CO₂ connector, a tissue specimen holder, nine specimen baskets and three specimen basket carriers.

- B7010A** Jumbo critical point dryer

Accessories

- B7011A** Specimen holder for grids, 3.05 mm
- B7012A** Specimen holder for grids, 2.3 mm
- B7013A** Specimen holder for tissue
- B7031A** Specimen holder for coverslips
- B7895** Porous specimen pots, 12.7 x 13 mm. Pack of 10
- B7025A** Complete set of gaskets

Replacement parts also available.

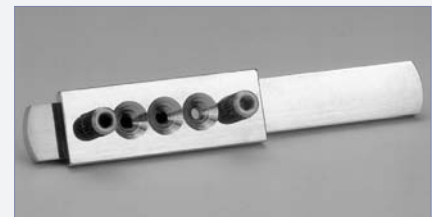

Thermo-electric critical point dryer

This thermo-electric critical point dryer has a 47 mm high vertical chamber with an internal diameter of 32 mm, allowing top loading of specimens. A side viewing port gives a good view of the liquid meniscus during filling. It is fitted with a thermo-electric heating and adiabatic cooling system, offering temperature control from 5 to 35 °C during heating. This ensures the critical point is accurately obtained, avoiding excess pressures or temperatures, and eliminates the need for a pressure relief valve control during the heating cycle. The standard specimen holder has 12 individual wells, each 8 mm in diameter and 8 mm high. This compact two-level holder allows easy specimen exchange and transfer to and from the dryer. It is supplied with a high pressure CO₂ hose, stainless steel specimen holder and 10 porous PTFE specimen pots.

- B7890** Thermo-electric critical point dryer

Accessories

- B7890A** Holder for TEM grids
- B7890B** Holder for coverslips
- B7890C** Holder for bulk samples
- B7895** Porous specimen pots, 12.7 x 13 mm. Pack of 10

Replacement parts also available.



Biological specimen preparation

Thermocirculators

With both **B7010** and **B7010A** the temperature of the chamber is raised by a hot water supply. A more elegant method involves the use of a water circulator or a combined water chiller/heater.

Thermocirculator



500 W water heater/circulator with a working range from ambient to 60 °C, allowing the temperature of circulating fluid to be pre-set. It can be connected directly to the water jacket inlet/outlet of critical point dryers, and is fitted with an over temperature cut out.

B7020 Thermocirculator (heating only)

Water chiller/thermocirculator



A water chiller/thermocirculator offering accurate temperature control from -5 to 60 °C. It can be used to pre-cool the chamber prior to specimen loading then increase the temperature to the critical point. It has a 400 W heater, and is fitted with an over temperature cut out. Dimensions: 370 x 320 x 460 mm. Weight: 40 kg.

B7024 Water chiller/thermocirculator

Specimen containers for CPD

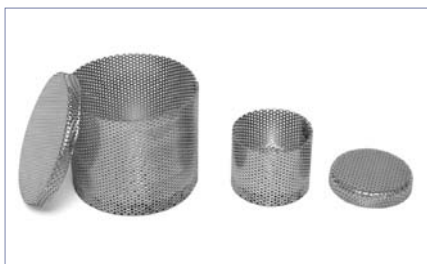

These are useful for processing specimens in a critical point drier. Two sizes are available.

B7902 Small screen tissue basket and lid, 15 (dia) x 10 (h) mm

B7903 Large screen tissue basket and lid, 23 (dia) x 18 (h) mm

Microporous specimen capsules and caps



Capsules to protect specimens during critical point drying. The capsules and close fitting caps are solvent resistant. Available in one pore size and supplied in packs of 10.

External dimensions: 12 x 13 mm. Internal dimensions: 9 x 5 mm.

G3767 Microporous specimen capsules, 120 - 200 µm pores

PELCO BioWave® Pro tissue processing system

The PELCO BioWave is a sophisticated microwave tissue processing system. This equipment has been designed with the aid of more than 15 years of microwave development experience and by reference to many published articles.

It enables rapid specimen processing with consistently high quality results. It has self-calibrated variable wattage and unique precise temperature control, as well as the convenience of remote process monitoring. Standard protocols are pre-programmed into the system. There is an intelligent touchscreen control panel for editing and adding new protocols.

It can be configured for specific applications by the use of kits for:

- TEM specimen processing, staining and labelling
- Immunolabelling
- Formaldehyde fixation and decalcification
- Paraffin tissue processing
- Confocal microscopy and *in situ* hybridisation



Please ask for full details.

Microwave accessories

Polypropylene Petri dishes

These are sturdy dishes suitable for microwave use.

G3506 Polypropylene Petri dishes, 50 x 15 mm. Pack of 100



Flat bottomed capsules

These polypropylene flat bottomed capsules are suitable for processing specimens in microwave systems.

G3547 Flat bottomed capsules, size 00. Pack of 100

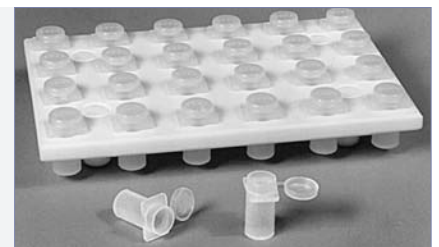

Microwave capsule holder with lid



This holder made from microwave transparent Teflon® holds up to 24 size 00 capsules, either flat bottomed or standard BEEM®. The capsules are firmly held in the water bath during curing.

G3508A Microwave capsule holder

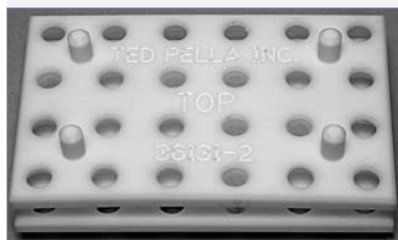

Microwave holder for microcentrifuge tubes



This holder made from Teflon® is designed to hold up to 18 conventional polyethylene microcentrifuge tubes firmly in the water bath during curing.

G3509 Microcentrifuge tube holder

Microwave polymerisation tray



This tray can be used with the capsule (**G3508A**) and centrifuge holders (**G3509**). The water in the tray helps to equilibrate the temperature during the curing of the resin.

L4504 Microwave polymerisation tray

EasiGlow™ discharge cleaning system

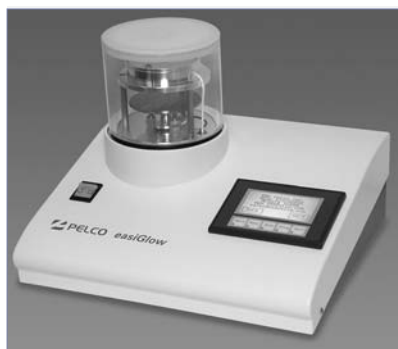

This is a compact, stand alone, easy to use discharge cleaning system primarily designed for surface modification of TEM support films. The system supports both hydrophilic and hydrophobic treatments for either a negative or positive charge and includes two separately controlled gas inlets.

The EasiGlow discharge unit features a specially designed glow discharge head, a sensible chamber size and an adjustable stage with glass slide holder, allowing easy loading and fast sample turnaround times. The system is microprocessor controlled and incorporates an intelligent touchscreen device allowing both full manual and automatic control of operation parameters. A soft venting procedure ensures that the TEM grids are not disturbed when the system is vented. The system is supplied complete with a pump and connection kit. If using an existing pump, then a connection kit will be required.

B7361 EasiGlow discharge unit

B7363 Javac CC31 stage rotary vane pump, 0.03 mbar, 240 v 50 Hz 1 ph
(available with NW16 inlet)

B7362 Pump connection kit